







- 1 | Disponibles en vidrio transparente, topacio, azul cobalto y verde
- 2 | Cumplen las especificaciones de la Farmacopea Europea y de Estados Unidos
- 3 | Sistema de control de calidad del producto garantizado con análisis físicos y químicos: verificación de las características dimensionales, resistencia al choque térmico, resistencia hidrolítica y resistencia a la presión
- 4 | Fabricados en vidrio sodocálcico tipo III
- 5 | Rosca DIN 18 (consulte los tapones disponibles para frascos ENDO-glassware)







- 1 | Available in transparent, amber glass, cobalt blue and green
- 2 | They meet the specifications of the European and US Pharmacopeia
- 3 | Guaranteed quality control system of the product with physical and chemical tests: verification of the dimensions and the thermal shock, hydrolytic and pressure resistances.
- 4 | Made of soda-lime glass type III
- 5 | Thread DIN 18 (see available stoppers for ENDOglassware bottles)

Vidrio topacio / Amber glass



Referencia Code						
12011051	5 mL	6,7 mL	50,2 mm	22,0 mm	DIN 18	22,0 g
12011101	10 mL	12,5 mL	58,0 mm	24,8 mm	DIN 18	27,5 g
12011111	15 mL	20,0 mL	65,0 mm	28,5 mm	DIN 18	35,0 g
12011131	30 mL	35,0 mL	78,8 mm	33,0 mm	DIN 18	48,0 g
12011151	50 mL	57,0 mL	92,2 mm	37,2 mm	DIN 18	55,0 g
12011201	100 mL	105,0 mL	112,0 mm	44,5 mm	DIN 18	88,0 g

Vidrio transparente / Transparent glass







Referencia Code						
12011050	5 mL	6,7 mL	50,2 mm	22,0 mm	DIN 18	22,0 g
12011100	10 mL	12,5 mL	58,0 mm	24,8 mm	DIN 18	27,5 g
12011110	15 mL	20,0 mL	65,0 mm	28,5 mm	DIN 18	35,0 g
12011130	30 mL	35,0 mL	78,8 mm	33,0 mm	DIN 18	48,0 g
12011150	50 mL	57,0 mL	92,2 mm	37,2 mm	DIN 18	55,0 g
12011200	100 mL	105,0 mL	112,0 mm	44,5 mm	DIN 18	88,0 g

Nota: el fabricante se reserva el derecho de modificar las características y fotografías de los productos.
Note: Manufacturer reserves the right to modify features and photographs of the goods.









Vidrio azul cobalto / Cobalt blue glass



Referencia Code						
12011052	5 mL	6,7 mL	50,2 mm	22,0 mm	DIN 18	22,0 g
12011102	10 mL	12,5 mL	58,0 mm	24,8 mm	DIN 18	27,5 g
12011112	15 mL	20,0 mL	65,0 mm	28,5 mm	DIN 18	35,0 g
12011132	30 mL	35,0 mL	78,8 mm	33,0 mm	DIN 18	48,0 g

Vidrio verde / Green glass



Referencia Code						
12011053	5 mL	6,7 mL	50,2 mm	22,0 mm	DIN 18	22,0 g
12011103	10 mL	12,5 mL	58,0 mm	24,8 mm	DIN 18	27,5 g
12011113	15 mL	20,0 mL	65,0 mm	28,5 mm	DIN 18	35,0 g
12011133	30 mL	35,0 mL	78,8 mm	33,0 mm	DIN 18	48,0 g

Nota: el fabricante se reserva el derecho de modificar las características y fotografías de los productos.
Note: Manufacturer reserves the right to modify features and photographs of the goods.



dimensiones de la rosca
thread dimensions

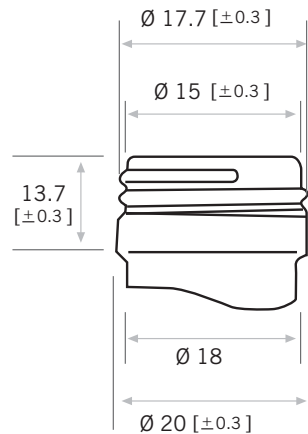

Tapón seguridad cuenta gotas interno / Safety stopper with inner dropper

Tapón de seguridad para niños con precinto y cuenta gotas interno, fabricado en polietileno y disponible en dos colores diferentes: blanco y amarillo.

Kid safety stopper with with seal and inner dropper, made of polyethylene and available in different colours: white and yellow.



Referencia Code	Descripción Description
12011007	Tapón seguridad cuenta gotas interno blanco Safety stopper with inner dropper, white
12011008	Tapón seguridad cuenta gotas interno amarillo Safety stopper with inner dropper, yellow

Tapón cuentagotas con tubo de vidrio / Dropper stopper with glass tube

Tapón de polietileno con precinto, tetina (libre de látex) y tubo de vidrio.

Polyethylene stopper with seal, teat (latex free) and glass tube.



Referencia Code	Para frascos de For bottles
12011059	5 mL
12011109	10 mL
12011119	15 mL
12011139	30 mL
12011159	50 mL
12011209	100 mL

Nota: el fabricante se reserva el derecho de modificar las características y fotografías de los productos.
Note: Manufacturer reserves the right to modify features and photographs of the goods.

